

HITACHI

冲击电扳手 Impact Wrench

WR 14VB

使用说明书

HANDLING INSTRUCTIONS

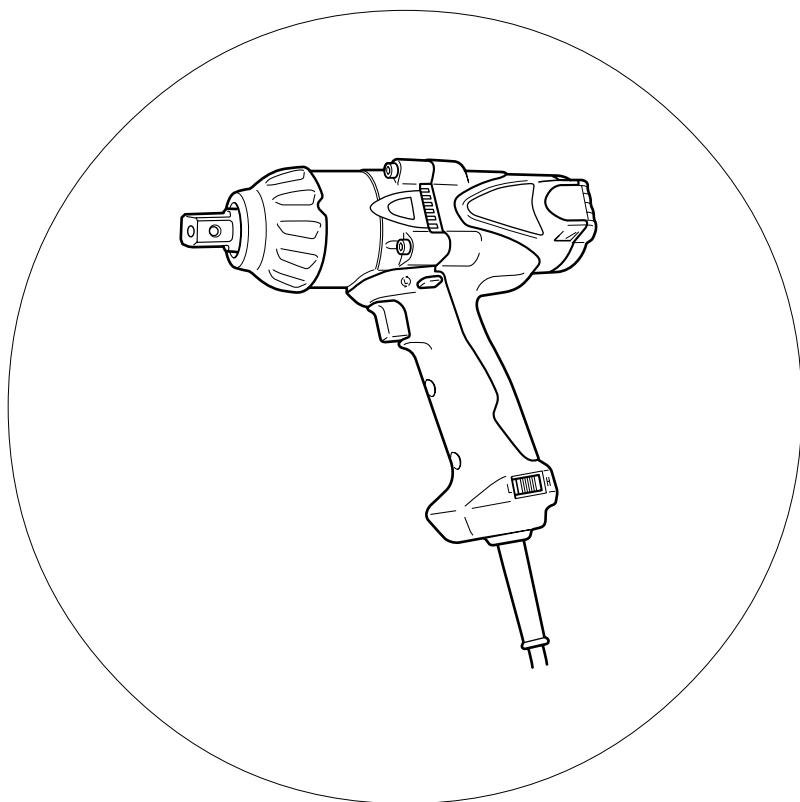

使用前务请详加阅读

Read through carefully and understand these instructions before use.

Hitachi Koki

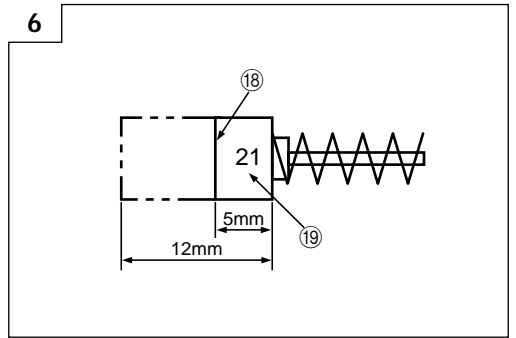
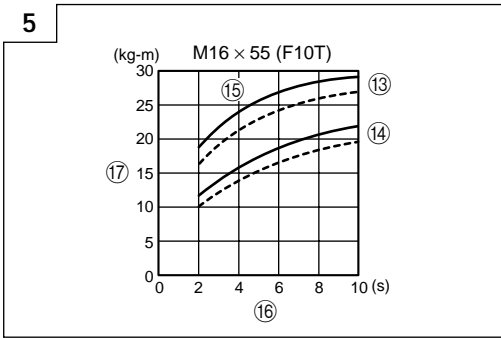
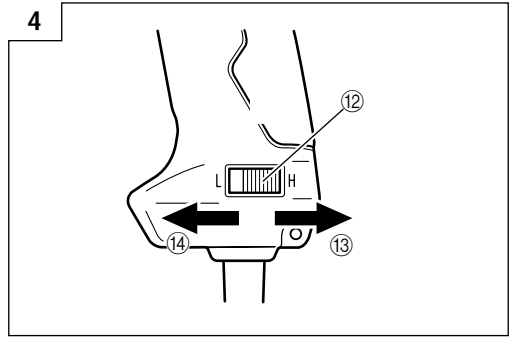
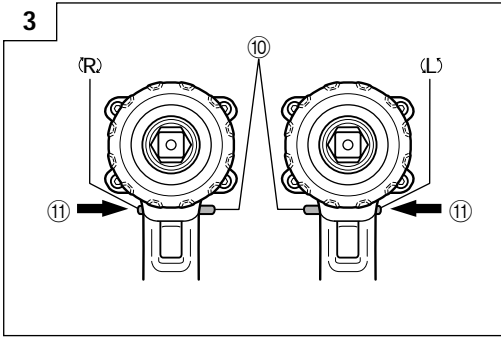
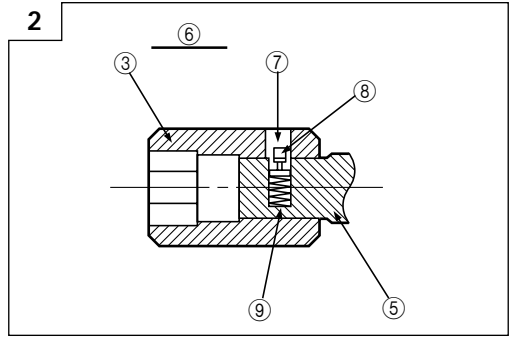
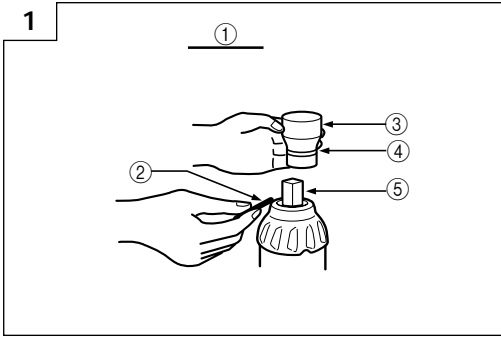

①	锚钉 o型环式	Pin O-Ring type
②	插销	Pin
③	六角套筒	Hex. socket
④	套环	Ring
⑤	铁砧	Anvil
⑥	活塞式	Plunger type
⑦	孔	Hole
⑧	活塞	Plunger
⑨	弹簧	Spring
⑩	按钮	Push button
⑪	按键	Push
⑫	变速杆	Speed change lever
⑬	高	High
⑭	低	Low
⑮	额定	Rating
⑯	旋紧时间	Tightening time
⑰	旋紧转矩	Tightening torque
⑱	磨损极限	Wear limit
⑲	碳刷号	No. of carbon brush

	<p>标志 ⚠ 警告 以下显示的是本机器中使用的标志，请确保您在使用前理解它们的含义。</p>	<p>Symbols ⚠ WARNING The following show symbols used for the machine. Be sure that you understand their meaning before use.</p>
	<p>为降低伤害风险，用户必须阅读使用说明书</p>	<p>To reduce the risk of injury, user must read instruction manual.</p>

电动工具通用安全警告

⚠ 警告！

阅读所有警告和所有说明。不遵照以下警告和说明会导致电击、着火和/或严重伤害。

保存所有警告和说明书以备查阅。

在所有下列的警告中术语“电动工具”指市电驱动（有线）电动工具或电池驱动（无线）电动工具。

1) 工作场地的安全

- a) 保持工作场地清洁和明亮。混乱和黑暗的场地会引发事故。
- b) 不要在易爆环境，如有易燃液体、气体或粉尘的环境下操作电动工具。电动工具产生的火花会点燃粉尘或气体。
- c) 让儿童和旁观者离开后操作电动工具。注意力不集中会使操作者失去对工具的控制。

2) 电气安全

- a) 电动工具插头必须与插座相配。绝不能以任何方式改装插头。需接地的电动工具不能使用任何转换插头。未经改装的插头和相配的插座将减少电击危险。
- b) 避免人体接触接地表面，如管道、散热片和冰箱。如果你身体接地会增加电击危险。
- c) 不得将电动工具暴露在雨中或潮湿环境中。水进入电动工具将增加电击危险。
- d) 不得滥用电线。绝不能用电线搬运、拉动电动工具或拔出其插头。使电线远离热源、油、锐边或运动部件。受损或缠绕的软线会增加电击危险。
- e) 当在户外使用电动工具时，使用适合户外使用的外接软线。适合户外使用的软线将减少电击危险。
- f) 如果在潮湿环境下操作电动工具是不可避免的，应使用剩余电流动作保护器（RCD）。使用RCD可减小电击危险。

3) 人身安全

- a) 保持警觉，当操作电动工具时关注所从事的操作并保持清醒。当你感到疲倦，或在有药物、酒精或治疗反应时，不要操作电动工具。在操作电动工具时瞬间的疏忽会导致严重人身伤害。
- b) 使用个人防护装置。始终佩戴护目镜。安全装置，诸如适当条件下使用防全面具、防滑安全鞋、安全帽、听力防护等装置能减少人身伤害。

- c) 防止意外起动。确保开关在连接电源和/或电池盒、拿起或搬运工具时处于关断位置。手指放在已接通电源的开关上或开关处于接通时插入插头可能会导致危险。
 - d) 在电动工具接通之前，拿掉所有调节钥匙或扳手。遗留在电动工具旋转零件上的扳手或钥匙会导致人身伤害。
 - e) 手不要伸展得太长。时刻注意立足点和身体平衡。这样在意外情况下能很好地控制电动工具。
 - f) 着装适当。不要穿宽松衣服或佩戴饰品。让衣服、手套和头发远离运动部件。宽松衣服、配饰或长发可能会卷入运动部件中。
 - g) 如果提供了与排屑、集尘设备连接用的装置，要确保它们连接完好且使用得当。使用这些装置可减少尘屑引起的危险。
- ### 4) 电动工具使用和注意事项
- a) 不要滥用电动工具，根据用途使用适当的电动工具。选用适当设计的电动工具会使你工作更有效、更安全。
 - b) 如果开关不能接通或关断工具电源，则不能使用该电动工具。不能用开关来控制的电动工具是危险的且必须进行修理。
 - c) 在进行任何调节、更换附件或贮存电动工具之前，必须从电源上拔掉插头和/或使电池盒与工具脱开。这种防护性措施将减少工具意外起动的危险。
 - d) 将闲置不用的电动工具贮存在儿童所及范围之外，并且不要让不熟悉电动工具或对这些说明不了解的人操作电动工具。电动工具在未经培训的用户手中是危险的。
 - e) 保养电动工具。检查运动件是否调整到位或卡住，检查零件破损情况和影响电动工具运行的其他状况。如有损坏，电动工具应在使用前修理好。许多事故由维护不良的电动工具引发。
 - f) 保持切削刀具锋利和清洁。保养良好的有锋利切削刃的刀具不易卡住而且容易控制。
 - g) 按照使用说明书，考虑作业条件和进行的作业来使用电动工具、附件和工具的刀头等。将电动工具用于那些与其用途不符的操作可能会导致危险。
- ### 5) 维修
- a) 将你的电动工具送交专业维修人员，使用同样的备件进行修理。这样将确保所维修的电动工具的安全性。

注意事项

不可让儿童和体弱人士靠近工作场所。应将不使用的工具存放在儿童和体弱人士接触不到的地方。

使用冲击电扳手时的 注意事项

1. 在紧固件可能触及暗线或其自身软线之处进行操作时，要通过绝缘握持面来握持工具。
紧固件碰到带电导线会使工具外露的金属零件带电从而使操作者受到电击。
2. 在高空使用本工具时，应确认底下是否有人。
3. 长时间使用本工具时，请使用耳塞。

4. 要改变扳手的旋转方向时，只能在马达完全停止后才能打开倒向开关。
5. 使用长的延长线时，请使用升压变压器。
6. 为了断定确实是使用了正确的旋紧转矩，请在使用本工具之前，用转矩扳手确认旋紧转矩。
7. 请用插销和套环，将套筒正确地装进冲击扳手上。
8. 请确认套筒内是否有裂缝。
9. 操作时，请紧紧握住冲击扳手的机身和边柄。否则，所产生的反作用力会导致不正确的操作，甚至会引起危险。

规格

电压（按地区）*	(110伏, 115伏, 120伏, 127伏, 220伏, 230伏, 240伏) ~
输入功率*	420瓦
无负荷速度（低/高）	0 - 1800 / 0 - 2300 / 分
旋紧能力 (螺母尺寸)	M8-M14 (高张力螺母) M10-M18 (普通螺母)
旋紧转矩**	低: 最大值18.8公斤·米 高: 最大值25.5公斤·米
交角传动	12.7毫米
重量（不带线缆）	2.2公斤

* 当须改变地区时应检查产品上的铭牌。

** 在额定电压的条件下拧紧螺母时，请勿使用延长线。

标准附件

- (1) 侧柄 1
- (2) 盒子 1

标准附件可能不预先通告而予以更改。

选购附件（分开销售）

1. 套筒的丰富多样性

尽管日立牌冲击扳手在出厂时，只备有一个标准套筒，但您可买到多种多样的套筒，用于各种尺寸与类型的螺母的冲击旋转。



表 1

B=12.7毫米

套筒设计	普通套筒				长形套筒				
	尺寸 (毫米)				尺寸 (毫米)				
	S	D	E	L	S	D	E	L	
六角形套筒	12				12	20	34	52	
	13				13	21.5	34	52	
	14	14	25	24	40	14	22	34	52
	17	17	28	15	32	17	25	34	52
	19	19	28	17	34	19	28	34	52
	21	21	32	19	36	21	31	34	52
	22	22	35	24	40	22	32.5	34	52
	23	23	36	25	40	23	33	34	52
	24	24	38	25	40	24	34	34	52
	26	26	38	25	40	26	38	57	75
	27	27	42	24	40	27	40	57	75

2. 延长杆

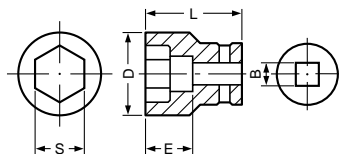
工作空间有限时，或所备的套筒难于碰到所要旋紧的螺母时，使用延长杆是极其方便的。

注意：

使用延长杆时，与普通转矩相比，旋紧转矩会稍微变小。因此，要想获得同样的转矩，需操作较长的时间。

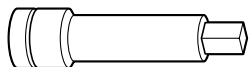

3. 万向接头

套筒和扳手之间有一角度时，或操作空间非常小时，使用万向接头来冲击螺母是极其方便的。

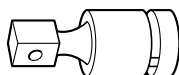

4. 转角零件 (EW-14R型)

本工具与螺母或螺栓的相对位置成直角时，可使用转角零件。

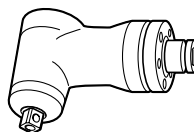

选购附件可能不预先通告而予以更改。

用途

- 各种螺栓、螺母的旋紧或旋松。

作业之前

1. 电源

确认所使用的电源与工具铭牌上标示的规格是否相符。

2. 电源开关

确认电源开关是否切断。若电源开关接通，则插头插入电源插座时电动工具将出其不意地立刻转动，从而招致严重事故。

3. 延伸线缆

若作业场所移到离开电源的地点，应使用容量足够、装合适的延伸线缆，并且要尽可能地短些。

4. 边柄的固定

装配在锤盒上的边柄位置可通过旋松边柄来改变（右侧的螺丝）。工作时，请将边柄旋转至所要的位置，并拧紧。

5. 选择合适的套筒

(1) 插销、O型套环（图 1）

请选择一个大小与需要旋紧或者旋松的螺栓相配的套筒。将其插进扳手的铁砧后，再用插销和套环将其固定住。拆卸套筒时，请按照与上述相反顺序进行操作。

(2) 活塞式（图 2）

将位于铁砧正方形部位上的活塞与六角插槽上的孔对准。然后压下活塞，将六角插槽安装在铁砧上。检查活塞和孔是否彻底结合。当拆卸插槽时，按相反顺序操作。

使用方法

1. 检查旋转方向

按下按钮 R 侧，套筒按顺时针（从后侧看）旋转。

按下按钮 L 侧，则套筒按逆时针旋转（见图 4）。

（机身上面有 **(R)** 和 **(L)** 标记。）

注意：

严禁在套筒扳手转动时按下按钮。若要按下按钮，请先停止套筒扳手，然后设置按钮。

2. 开关的操作

○ 当按下触发开关时，工具开始旋转。释放触发开关时，工具停止。

○ 可以通过改变触发开关牵拉的程度对旋转速度进行调节。当轻微地牵拉触发开关时，旋转速度放

慢；当对触发开关牵拉的程度加大时，旋转速度加快。

3. 调速杆的使用

如图 4 所示，将调速杆滑至右侧则速度增加，滑至左侧则速度降低。如果您想要降低最大应用扭矩，可以将调速杆滑至低速侧（见图 5）。

4. 旋紧或旋松螺栓

请事先选择一个与螺栓或螺母配套的六角套筒，然后将此套筒装配在铁砧上，并用六角套筒扣住所要旋转的螺母。将扳手对准螺栓，然后按下电源开关冲击螺母数秒钟。如果螺母一直不能被紧固地固定在螺栓上，则说明螺栓跟着螺母一起在转。这时，请停止冲击，用另一个扳手固定住螺栓头部然后再重新冲击或用手旋紧螺栓和螺母以防它们滑动。

操作时的注意事项

1. 确保线电压（图 5）

有效旋紧转矩会受到线电压的影响。电压的减少会降低有效旋紧转矩。

例如：如果您在 200 伏电压环境下使用 220 伏型扳手时，转矩会降低至 70% 到 90%。需要使用电源延长线时，应尽量使用短的延长线。当线电压较低时又要使用长的电源延长线时，请使用升压变压器。线电压与旋紧转矩之间的关系如各图所示。

2. 在连续操作时不要接触减震器和电动锤

在连续旋转上紧过程中减震器和电动锤会变热，所以在这过程中务必要小心不要接触它们。

3. 使用最佳旋紧转矩

最适合螺母和螺栓的旋紧转矩因螺母和螺栓的材料、尺寸而导。对小的螺栓施加过大的旋紧转矩会导致螺栓的变形或断裂。旋紧转矩随着操作时间的增加而增大，请正确掌握对螺栓的操作时间。

4. 选择与螺栓相配的套筒

注意要选择使用与螺栓相配的套筒，使用不相配的套筒时，不仅会影响旋紧力，还会使套筒或螺母受损。

如使用已损坏了的、或已变形的六角或四角套筒，由于无法得到适当的旋紧力，因而会导致旋紧转矩的损失。

请注意套筒内部的磨损，并在磨损程度加重之前更换之。和螺栓尺寸配套的套筒示于表1。

套筒牌号处的数值表示六角型孔的一边到另外一边的距离 (S)。

5. 扳手的拿法

请用双手紧紧地握住冲击扳手的主柄和边柄。并将扳手对准螺栓。

没有必要对扳手施加太大的力，只需施加可抵消冲击力的力即可。

6. 确保施紧转矩

以下各个因素与旋紧转矩相关。为了确保旋紧转矩，必须在开始操作之前先用普通的扳手把螺栓旋紧。

与旋紧转矩相关的因素如下：

(1) 线电压

旋紧转矩会随着线电压的降低而减小。

(请参考 图 5)

(2) 操作时间

旋紧转矩会随着操作时间的增加而增大。但是，旋紧转矩达到临界值后，即使操作时间再长旋紧转矩也不再增大。(请参考 图 5)

(3) 螺栓的直径

旋紧转矩会因螺母的直径而导 (请参考 图 5)。通常，螺母的直径越大，旋紧转矩便也越大。

(4) 旋紧条件

即使螺纹尺寸相同，旋紧转矩也因转矩率、螺栓的级别、及螺栓长度而异。另外，各螺栓的金属表面的状况不同也会导致各旋紧转矩相异。

(5) 选购附件的使用

使用延长柄、万向接头、或长的套筒时，旋紧转矩会相对减少。

(6) 套筒的障碍排除

如使用已损坏了的、或已变形的六角或四角套筒，由于无法得到适当的旋紧力，因而会导致旋紧转矩的损失。

使用和螺栓不相配的套筒时，将不能获得足够得旋紧转矩。和螺栓尺寸配套的套筒示于表1。

紧转矩的损失。请对套筒内部的磨损程度紧行周期检查，必要时请换上新的套筒。

2. 检查安装螺钉

要经常检查安装螺钉是否紧固妥善。若发现螺钉松了，应立即重新扭紧，否则会导致严重事故。

3. 电动机的维护

电动机绕线是电动工具的“心脏部”应仔细检查有无损伤，是否被油液或水沾湿。

4. 检查碳刷

为了保证长期的安全使用以及避免触电事故的发生，本工具的碳刷检查与更换只能由日立授权的服务中心进行。

5. 更换电源线

如果工具的电源线破损，必须将工具送回日立授权的服务中心来更换电源线。

6. 维修零部件一览表

注意：

日立牌电动工具的维修、改造和检查须由经日立公司授权的维修中心进行。

当要求维修或其他保养服务时，若将此零部件一览表与电动工具一起呈交给经日立公司授权的维修中心，将有助于维修或保养工作。

在操作和维修电动工具时，必须遵守贵国制定的安全的有关规则和标准。

改造：

日立牌电动工具经常加以改善和改造以采用最新的先进技术。

因此，某些零部件可能变更，恕不另行通知。

注：

为求改进，本手册所载规格可能不预先通告而予以更改。

维护和检查

1. 套筒的检查

如使用已损坏了的、或已变形的六角或四角套筒，由于无法得到适当的旋紧力，因而会导致旋

GENERAL POWER TOOL SAFETY WARNINGS

WARNING

Read all safety warnings and all instructions.

Failure to follow the warnings and instructions may result in electric shock, fire and/or serious injury.

Save all warnings and instructions for future reference.

The term "power tool" in the warnings refers to your mains-operated (corded) power tool or battery-operated (cordless) power tool.

1) Work area safety

- a) **Keep work area clean and well lit.**
Cluttered or dark areas invite accidents.
- b) **Do not operate power tools in explosive atmospheres, such as in the presence of flammable liquids, gases or dust.**
Power tools create sparks which may ignite the dust or fumes.
- c) **Keep children and bystanders away while operating a power tool.**
Disjéactions can cause you to lose control.

2) Electrical safety

- a) **Power tool plugs must match the outlet. Never modify the plug in any way. Do not use any adapter plugs with earthed (grounded) power tools.**
Unmodified plugs and matching outlets will reduce risk of electric shock.
- b) **Avoid body contact with earthed or grounded surfaces, such as pipes, radiators, ranges and refrigerators.**
There is an increased risk of electric shock if your body is earthed or grounded.
- c) **Do not expose power tools to rain or wet conditions.**
Water entering a power tool will increase the risk of electric shock.
- d) **Do not abuse the cord. Never use the cord for carrying, pulling or unplugging the power tool. Keep cord away from heat, oil, sharp edges or moving parts.**
Damaged or entangled cords increase the risk of electric shock.
- e) **When operating a power tool outdoors, use an extension cord suitable for outdoor use.**
Use of a cord suitable for outdoor use reduces the risk of electric shock.
- f) **If operating a power tool in a damp location is unavoidable, use a residual current device (RCD) protected supply.**
Use of an RCD reduces the risk of electric shock.

3) Personal safety

- a) **Stay alert, watch what you are doing and use common sense when operating a power tool. Do not use a power tool while you are tired or under the influence of drugs, alcohol or medication. A moment of inattention while operating power tools may result in serious personal injury.**
- b) **Use personal protective equipment. Always wear eye protection.**
Protective equipment such as dust mask, non-skid safety shoes, hard hat, or hearing protection used for appropriate conditions will reduce personal injuries.
- c) **Prevent unintentional starting. Ensure the switch is in the off-position before connecting to power source and/or battery pack, picking up or carrying the tool.**

Carrying power tools with your finger on the switch or energising power tools that have the switch on invites accidents.

- d) **Remove any adjusting key or wrench before turning the power tool on.**
A wrench or a key left attached to a rotating part of the power tool may result in personal injury.
- e) **Do not overreach. Keep proper footing and balance at all times.**
This enables better control of the power tool in unexpected situations.
- f) **Dress properly. Do not wear loose clothing or jewellery. Keep your hair, clothing and gloves away from moving parts.**
Loose clothes, jewellery or long hair can be caught in moving parts.
- g) **If devices are provided for the connection of dust extraction and collection facilities, ensure these are connected and properly used.**
Use of dust collection can reduce dust related hazards.

4) Power tool use and care

- a) **Do not force the power tool. Use the correct power tool for your application.**
The correct power tool will do the job better and safer at the rate for which it was designed.
- b) **Do not use the power tool if the switch does not turn it on and off.**
Any power tool that cannot be controlled with the switch is dangerous and must be repaired.
- c) **Disconnect the plug from the power source and/or the battery pack from the power tool before making any adjustments, changing accessories, or storing power tools.**
Such preventive safety measures reduce the risk of starting the power tool accidentally.
- d) **Store idle power tools out of the reach of children and do not allow persons unfamiliar with the power tool or these instructions to operate the power tool. Power tools are dangerous in the hands of untrained users.**
- e) **Maintain power tools. Check for misalignment or binding of moving parts, breakage of parts and any other condition that may affect the power tool's operation.**
If damaged, have the power tool repaired before use. Many accidents are caused by poorly maintained power tools.
- f) **Keep cutting tools sharp and clean.**
Properly maintained cutting tools with sharp cutting edges are less likely to bind and are easier to control.
- g) **Use the power tool, accessories and tool bits etc. in accordance with these instructions, taking into account the working conditions and the work to be performed.**
Use of the power tool for operations different from those intended could result in a hazardous situation.

5) Service

- a) **Have your power tool serviced by a qualified repair person using only identical replacement parts.**
This will ensure that the safety of the power tool is maintained.

PRECAUTION

Keep children and infirm persons away.

When not in use, tools should be stored out of reach of children and infirm persons.

PRECAUTIONS ON USING IMPACT WRENCH

1. Hold power tool by insulated gripping surfaces, when performing an operation where the fastener may contact hidden wiring or its own cord. Fasteners contacting a "live" wire may make exposed metal parts of the power tool "live" and could give the operator an electric shock.
2. When using the tool at a height, make sure that there is nobody below.
3. Use earplugs if using for a long time use.
4. Switch the reversing switch only after the motor has stopped when it is necessary to change the direction of the rotation.
5. Use a step up transformer when a long extension cable is used.
6. Confirm the tightening torque by a torque wrench before use in order to ascertain the correct tightening torque to be used.
7. Assemble the socket securely to the impact wrench with the socket pin and ring.
8. Confirm whether the socket has any cracks in it.
9. Always hold the body and side handles of the impact wrench firmly. Otherwise the counterforce produced may result in inaccurate and even dangerous operation.

SPECIFICATIONS

Voltage (by areas)*	(110V, 115V, 120V, 127V, 220V, 230V, 240V) ~
Power input*	420 W
No load speed (Low/High)	0 - 1800 / 0 - 2300/min.
Capacities (size of bolts)	M8-M14 (High tension bolt) M10-M18 (Ordinary bolt)
Tightening torque**	Low: Maximum 18.8 kg-m High: Maximum 25.5 kg-m
Angle drive	12.7 mm
Weight (without cord)	2.2 kg

*Be sure to check the nameplate on product as it is subject to change by areas.

**Tightening the bolt without extension cord at rated voltage.

STANDARD ACCESSORIES

- (1) Side handle 1
 (2) Case 1
 Standard accessories are subject to change without notice.

OPTIONAL ACCESSORIES (sold separately)

1. Variety of sockets

Although the Hitachi Impact Wrench is delivered with only one standard socket, ample sockets are available to cover impact tightening of various sizes and types of bolts.

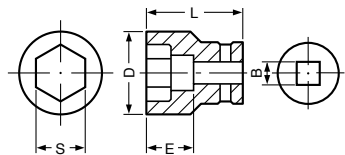

Table 1

B = 12.7 mm

Socket Designation	Ordinary Socket Dimension (mm)				Long Socket Dimension (mm)			
	S	D	E	L	S	D	E	L
Hex. Socket 12					12	20	34	52
13					13	21.5	34	52
14	14	25	24	40	14	22	34	52
17	17	28	15	32	17	25	34	52
19	19	28	17	34	19	28	34	52
21	21	32	19	36	21	31	34	52
22	22	35	24	40	22	32.5	34	52
23	23	36	25	40	23	33	34	52
24	24	38	25	40	24	34	34	52
26	26	38	25	40	26	38	57	75
27	27	42	24	40	27	40	57	75

2. Extension bar

The extension bar is convenient for working in very restricted spaces or when the socket provided cannot reach the bolt to be tightened.

CAUTION

When the extension bar is used the tightening torque is reduced slightly compared with the ordinary socket. So it is necessary to operate the tool a little longer to get the same torque.

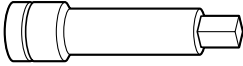

3. Universal joint

The universal joint is convenient for impacting nuts when there is an angle between the socket and wrench, or when working in a very narrow space.

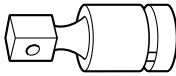

4. Corner attachment (Model EW-14R)

Use this attachment only when the machine is applied to the nut or bolt at a right angle.

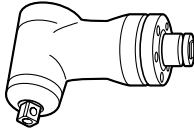

Optional accessories are subject to change without notice.

APPLICATIONS

- Tightening and loosening various kinds of bolt and nut.

PRIOR TO OPERATION

1. Power source

Ensure that the power source to be utilized conforms to the power requirements specified on the product nameplate.

2. Power switch

Ensure that the power switch is in the OFF position. If the plug is connected to a receptacle while the power switch is in the ON position, the power tool will start operating immediately, which could cause a serious accident.

3. Extension cord

When the work area is removed from the power source, use an extension cord of sufficient thickness an rated capacity. The extension cord should be kept as short as practicable.

4. Fixing the side handle

The position of the side handle attached to the hammer case can be changed by unscrewing the handle. (Right hand screw) Turn the handle to the desired position for the job and secure the handle by screwing up tight.

5. Mounting the socket

(1) Pin, O-ring type (Fig. 1)

Select a socket matched to the bolt to be tightened or loosened. Insert the socket on the anvil of the wrench, and secure it with the pin and ring. When dismantling the socket, reverse the sequence.

(2) Plunger type (Fig. 2)

Align the plunger located in the square part of the anvil with the hole in the hex socket. Then push the plunger, and mount the hex socket on the anvil. Check that the plunger is fully engaged in the hole. When removing the socket, reverse the sequence.

HOW TO USE

1. Check the rotational direction

The socket rotates clockwise (viewed from the rear side) by pushing the R-side of the push button. The L-side of the push button is pushed to turn the socket counterclockwise (See Fig. 4) (The (L) and (R) marks are provided on the body).

CAUTION

The push button can not be switched while the impact wrench is turning. To switch the push button, stop the impact wrench, then set the push button.

2. Switch operation

- When the trigger switch is depressed, the tool rotates. When the trigger is released, the tool stops.
- The rotational speed can be controlled by varying the amount that the trigger switch is pulled. Speed is low when the trigger switch is pulled slightly and increases as the trigger switch is pulled more.

3. Using the speed change lever

As shown in Fig. 4, slide the speed change lever to the right for high speed or slide to the left for low speed. Use the low speed side when you want to lower the maximum applied torque (See Fig. 5).

4. Tightening and loosening bolts

A hex socket matching the bolt or nut must first be selected. Then mount the socket on the anvil, and grip the nut to be tightened with the hex socket. Holding the wrench in line with the bolt, press the power switch to impact the nut for several seconds. If the nut is only loosely fitted to the bolt, the bolt may turn with the nut, therefore preventing proper tightening. In this case, stop impact on the nut and hold the bolt head with a wrench before restarting impact, or manually tighten the bolt and nut to prevent them slipping.

OPERATIONAL CAUTIONS

1. Confirm the line voltage (Fig. 5)

The available tightening torque is influenced by line voltage. Reduced line voltage lowers the available tightening torque.

For example, if you use a 220 V type wrench on a 200 V line the available tightening torque will be reduced to 70 to 90 %. When extending the power cord, use an extension cord which is as short as possible. When the line voltage is low and a long extension cord is needed a step up transformer should be used. The relation between the line voltage and the tightening torque are shown in the figures.

2. Do not touch the bumper or hammer case during continuous operation

The bumper and hammer case become hot during continuous screw tightening so be careful not to touch them at that time.

3. Work at a tightening torque suitable for the bolt under impact

The optimum tightening torque for nuts and bolts differs with material and size of the nuts and bolts. An excessively large tightening torque for a small bolt may stretch or break the bolt. The tightening torque increases proportionally to the operating time. Use the correct operating time for the bolt.

4. Selecting the socket to be matched to the bolt

Be sure to use a socket which is matched to the bolt to be tightened. Using an improper socket will result not only in insufficient tightening but also in damage to the socket or nut.

A worn or deformed hex or square-holed socket will not give an adequate tightness for fitting to the nut or anvil, consequently resulting in loss of tightening torque.

Pay attention to wear of socket holes, and replace before further wear develops. Matching socket and bolt sizes are shown in **Table 1**.

The numerical value of a socket designation denotes the side to side distance (S) of its hex hole.

5. Holding the tool

Hold the Impact Wrench firmly with both hands by the body handle and the side handle. In this case hold the wrench in line with the bolt.

It is not necessary to push the wrench very hard. Hold the wrench with a force just sufficient to counteract the impact force.

6. Confirm the tightening torque

The following factors contribute to a reduction of the tightening torque. So confirm the actual tightening torque needed by screwing up some bolts before the job with a hand torque wrench. Factors affecting the tightening torque are as follows.

(1) Line voltage:

The tightening torque decreases when the line voltage becomes low (See **Fig. 5**).

(2) Operating time:

The tightening torque increases when the operating time increases. But the tightening torque does not increase above a certain value even if the tool is driven for a long time (See **Fig. 5**).

(3) Diameter of bolt:

The tightening torque differs with the diameter of the bolt as shown in **Fig. 5**. Generally a larger diameter bolt has a larger tightening torque.

(4) Tightening conditions:

The tightening torque differs according to the torque ratio; class, and length of bolts even when bolts with the same size threads are used. The tightening torque also differs according to the condition of the surface of metal through which the bolts are to be tightened.

(5) Using optional parts:

The tightening torque is reduced a little when an extension bar, universal joint or a long socket is used.

(6) Clearance of the socket:

A worn or deformed hex or a square-holed socket will not give an adequate tightness to the fitting between the nut or anvil, consequently resulting in loss of tightening torque.

Using an improper socket which does not match to the bolt will result in an insufficient tightening torque. Matching socket and bolt sizes are shown in **Table 1**.

MAINTENANCE AND INSPECTION

1. Inspecting the socket

A worn or deformed hex or a square-holed socket will not give an adequate tightness to the fitting between the nut or anvil, consequently resulting in loss of tightening torque. Pay attention to wear of socket holes periodically, and replace with a new one if needed.

2. Inspecting the mounting screws

Regularly inspect all mounting screws and ensure that they are properly tightened. Should any of the screws be loose, retighten them immediately. Failure to do so could result in serious hazard.

3. Maintenance of the motor

The motor unit winding is the very "heart" of the power tool.

Exercise due care to ensure the winding does not become damaged and/or wet with oil or water.

4. Inspecting the carbon brushes

For your continued safety and electrical shock protection, carbon brush inspection and replacement on this tool should **ONLY** be performed by a Hitachi Authorized Service Center.

5. Replacing supply cord

If the supply cord of Tool is damaged, the Tool must be returned to Hitachi Authorized Service Center for the cord to be replaced.

6. Service parts list

CAUTION

Repair, modification and inspection of Hitachi Power Tools must be carried out by a Hitachi Authorized Service Center.

This Parts List will be helpful if presented with the tool to the Hitachi Authorized Service Center when requesting repair or other maintenance.

In the operation and maintenance of power tools, the safety regulations and standards prescribed in each country must be observed.

MODIFICATION

Hitachi Power Tools are constantly being improved and modified to incorporate the latest technological advancements.

Accordingly, some parts may be changed without prior notice.

NOTE

Due to HITACHI's continuing program of research and development, the specifications herein are subject to change without prior notice.

ITEM NO.	PART NAME	QTY
40	SUPPORT (B)	1
41	TERMINAL 50051	1
42	NAME PLATE	1
43	BALL BEARING 608VVC2PS2L	1
44	RUBBER WASHER	1
45	BEARING BUSHING (B)	1
46	TAIL COVER	1
47	TAPPING SCREW (W/FLANGE) D4 x 20	2
48	DIODE SWITCH	1
49	TAPPING SCREW (W/FLANGE) D4 x 16	2
50	CORD CLIP	1
51-1	CORD ARMOR D8.8	1
51-2	CORD ARMOR D10.1	1
52	CORD	1
53	TUBE (D)	2
54	HITACHI LABEL	1
55	BRUSH CAP	2
56	CARBON BRUSH	2
57	BRUSH HOLDER	2
58	HOUSING ASS'Y (INCLUD.57,59)	1
59	HEX. SOCKET SET SCREW M5 x 8	2
501	SIDE HANDLE ASS'Y	1
502	SIDE HANDLE (INCLUD.502-505)	1
503	HANDLE HOLDER	1
504	HANDLE RING	1
505	SQUARE BOLT M8	1
506	CASE (A)	1

ITEM NO.	PART NAME	QTY
1	BUMPER (B)	1
2	SEAL LOCK HEX. SOCKET HD. BOLT M5 x 40	4
3	HAMMER CASE ASS'Y (INCLUD.1,4,5)	1
4	O-RING (M)	1
5	METAL	1
6-1	ANVIL (G)	1
6-2	ANVIL (B) ASS'Y (INCLUD.13,14)	1
7	STEEL BALL D6.35	2
8	HAMMER	1
9	STEEL BALL D3.97	29
10	WASHER (B)	1
11	SPRING	1
12	WASHER (A)	1
13	PIN RETAINER (A)	1
14	PLUNGER (A)	1
15	NEEDLE ROLLER	2
16	SPINDLE	1
17	IDLE GEAR SET	2
18	RING GEAR	1
19	BALL BEARING 6807ZZ-N	1
20	GASKET (A)	1
21	INNER COVER	1
22	FELT PACKING	1
23	PACKING WASHER	1
24	BALL BEARING 608DDC2PS2L	1
25	ARMATURE	1
26	FAN GUIDE	1
27	HEX. HD. TAPPING SCREW D4 x 45	2
28	STATOR	1
29	INTERNAL WIRE (WHITE)	1
30	CHOKE COIL (WHITE)	1
31	INTERNAL WIRE (BLACK)	1
32	CHOKE COIL (BLACK)	1
33	TAPPING SCREW (W/FLANGE) D4 x 35	2
34	HANDLE COVER	1
35	PUSHING BUTTON (A)	1
36	SWITCH	1
37	CONNECTOR 50092	1
38	NOISE SUPPRESSOR ASS'Y (W/RESISTOR)	1
39	SUPPORT (B)	1

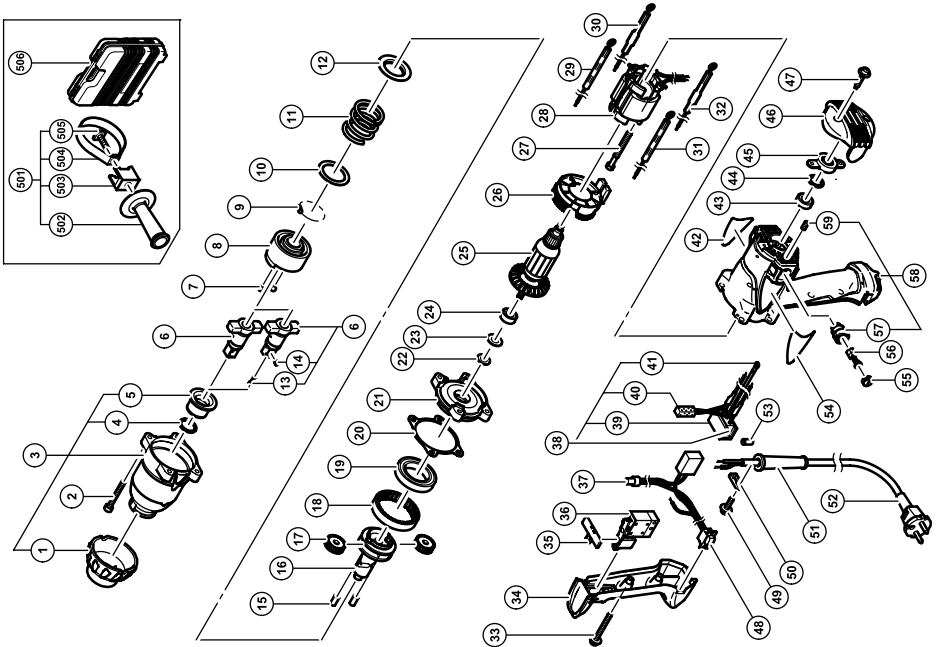

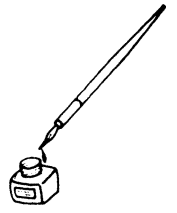

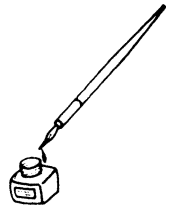

服务中心
日立工机商业（中国）有限公司
上海市长宁区遵义南路88号协泰中心19B-C

制造商
日立工机株式会社
日本国茨城县常陆那珂市武田1060番地

 **Hitachi Koki Co., Ltd.**