

# HITACHI

充电器  
Charger

中文  
English

## UC 36YSL

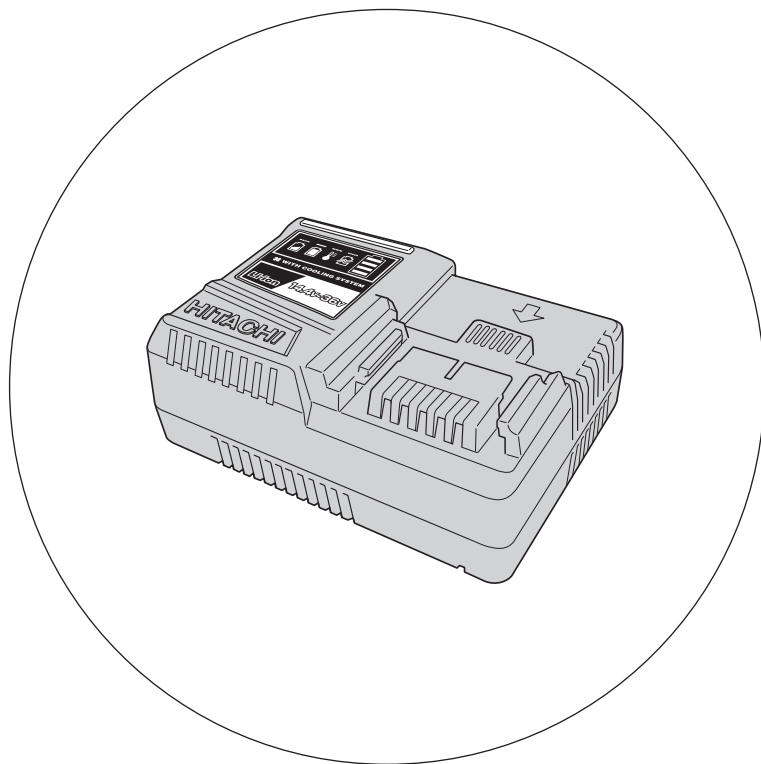

保留备用  
Keep for future reference



使用说明书  
Handling instructions

Hitachi Koki

## 目次

一般操作注意事项.....	2	用途.....	4
有关充电器的注意事项.....	3	充电.....	5
符号.....	3	维护和检查.....	9
规格.....	4	维修零部件一览表.....	10

## 一般操作注意事项

1. 保持工作场所清洁。杂乱的场所和工作台易发生意外。
2. 避免危险的环境。请勿让电动工具和充电器淋雨。请勿在潮湿的地方使用电动工具和充电器。请保持工作场所明亮。  
切勿在易燃性或爆炸性物体附近使用电动工具和充电器。  
请勿在有易燃液体或气体存在的地方使用工具和充电器。
3. 本产品并非供身体、感官、心理能力较差或缺乏经验和知识的人员（包括小孩）使用，除非他们得到了对其安全负责的人员关于本产品使用的监督或指导。  
应监督小孩，确保他们不玩弄本产品。
4. 收藏停用的工具和充电器。工具和充电器不用时，应收藏在干燥、较高或上锁（小孩拿不到）的地方。请将工具和充电器收藏在温度低于 40°C 的地方。
5. 请勿滥用电源线。切勿用电源线来携带充电器或猛拉电源线来将其从插座上拔下。请使电源线远离热、油和尖锐的边缘。
6. 不使用充电器或正在维护和检查时，请将充电器的电源线从插座上拔下。
7. 为了避免危险，请仅使用指定的充电器。
8. 请仅使用正宗日立更换零件。
9. 请勿将电动工具和充电器用于使用说明书中指定的用途之外。
10. 为了避免人体受伤，请仅使用使用说明书或日立商品目录中推荐的配件或附件。
11. 如果电源线损坏，必须由厂家或其维修代理或类似有资格的人员更换以防发生危险。  
请仅让授权服务中心进行修理。厂家对由未授权的人员修理或工具使用不当引起的任何损坏或伤害不承担责任。
12. 为了确保电动工具和充电器的操作整体性，请勿拆下装在上面的盖子或螺钉。
13. 请始终在标牌上所示的电压下使用充电器。
14. 使用前请对电池充电。
15. 切勿使用指定电池之外的电池。请勿将通常的干电池、指定之外的电池或汽车电池连接到电动工具。
16. 请勿使用带增压器的变压器。
17. 请勿从直流电源对电池进行充电。
18. 请始终在室内充电。因为充电期间充电器和电池会有些发热，所以请在没有阳光直射、湿度较低和通风良好的地方给电池充电。
19. 请将本使用说明书中的立体分解图仅用于授权维修。

## 有关充电器的注意事项

1. 请始终在  $-10$  至  $40^{\circ}\text{C}$  的环境温度下对电池进行充电。温度低于  $-10^{\circ}\text{C}$  将导致危险的过充电。不得在高于  $40^{\circ}\text{C}$  的温度下对电池进行充电。  
最适于充电的温度是  $20$  至  $25^{\circ}\text{C}$ 。
2. 请勿连续使用充电器。  
充电结束后，在下次充电之前请将充电器放置约 15 分钟。
3. 勿让杂质进入电池的连接口内。
4. 切勿拆卸本电池或充电器。
5. 切勿使电池短路。  
使电池短路将会造成很大的电流和过热，从而烧坏电池。
6. 请勿将电池丢入火中。  
电池受热将会爆炸。
7. 使用耗尽的电池会损坏充电器。
8. 充电后的电池寿命太短不够使用时，请尽快将本电池送往购买时的经销店。  
请勿将用过的电池乱丢。
9. 请勿将异物插入充电器的通风口。  
将金属物体或易燃物插入充电器的通风口会导致触电事故或损坏充电器。

## 符号

### 警告！

如下所示的符号用于本机。使用前请务必理解其含意。



阅读所有安全警告和所有指示。

## 规格

充电器

( ): 节电池

充电时间	1.3 Ah	BSL1415S (4), BSL1815S (5)	约 15 分钟
	1.5 Ah	BSL1415 (4), BSL1415X (4), BSL1815 (5), BSL1815X (5)	约 15 分钟
	2.0 Ah	BSL1420 (4), BSL1820 (5), BSL3620 (10)	约 20 分钟
	2.5 Ah	BSL1425 (4), BSL1825 (5), BSL3625 (10)	约 25 分钟
	2.6 Ah	BSL3626 (20), BSL3626X (20)	约 25 分钟
	3.0 Ah	BSL1430 (8), BSL1830 (10), BSL2530 (14)	约 30 分钟
	4.0 Ah	BSL1440 (8), BSL1840 (10)	约 40 分钟
	5.0 Ah	BSL1450 (8), BSL1850 (10)	约 50 分钟
	6.0 Ah	BSL1460 (8), BSL1860 (10), BSL3660 (20)	约 60 分钟
充电电压	14.4 V - 36 V		
重量	0.9 kg		

## 用途

对日立电池充电。

- BSL1415S, BSL1415, BSL1415X, BSL1420, BSL1425, BSL1430, BSL1440, BSL1450, BSL1460, BSL1815S, BSL1815, BSL1815X, BSL1820, BSL1825, BSL1830, BSL1840, BSL1850, BSL1860, BSL2530, BSL3620, BSL3625, BSL3626, BSL3626X, BSL3660

# 充电

使用电动工具之前，按下述方法将电池进行充电。

1. 将充电器的电源线连接到插座。(图 1)

当充电器的插头接上插座时，充电指示灯将呈红色闪烁。(闪烁间隔为 1 秒)

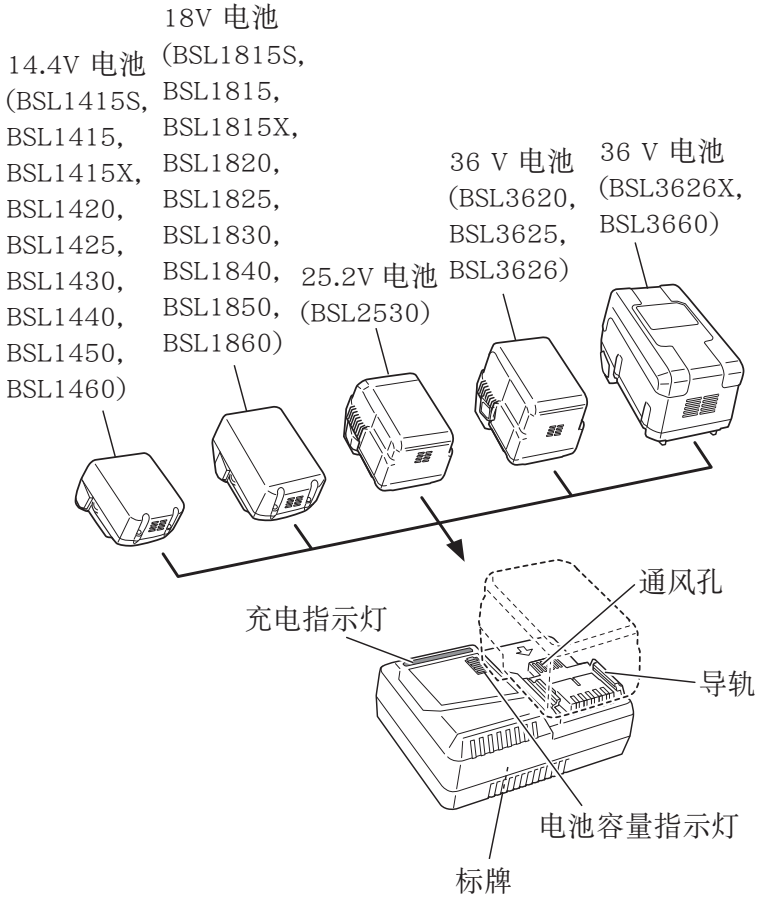

插入前

图 1

# 中文

2. 将电池插入充电器。

如第 5 页的图 1 所示，将电池紧紧地插入充电器。

3. 充电





将电池插入充电器后，充电器上的充电指示灯将持续点亮呈蓝色。

电池完全充电后，充电器上的充电指示灯将持续点亮呈绿色。（参照表 1）。

(1) 充电指示灯显示

根据充电器或电池的情况，充电指示灯的显示如表 1 所示。

表 1

充电指示灯的显示				
充电指示灯 (红色 / 蓝色 / 绿色 / 紫色)	充电前	闪烁 (红色)	点亮 0.5 秒钟。不点亮 0.5 秒钟。(熄灭 0.5 秒钟) 	接入电源
	充电时	点亮 (蓝色)	连续点亮 	/
	充电完成	点亮 (绿色)	连续点亮 (连续蜂鸣器声：约 6 秒) 	
	过热而等待	闪烁 (红色)	点亮 0.3 秒钟。不点亮 0.3 秒钟。(熄灭 0.3 秒钟) 	电池过热。 无法充（电池冷却后开始进行充电）。
	无法充电	闪动 (紫色)	点亮 0.1 秒钟。不点亮 0.1 秒钟。(熄灭 0.1 秒钟)  (断断续续的蜂鸣器声：约 2 秒)	电池或充电器故障。

注：

当冷却电池待机时，UC36YSL 通过冷却扇来冷却过热电池。

(2) 关于电池容量指示灯





使用电池容量指示灯可以检查正在充电的电池充电容量。

电池容量指示灯的显示如表 2 所示。

注：

充电完成后片刻，电池容量指示灯熄灭。

表 2

指示灯状态	电池容量
 闪烁	电池容量低于 25%
 闪烁	电池容量低于 50%
 闪烁	电池容量低于 75%
 闪烁	电池容量高于 75%
 点亮	充电完成

## (3) 关于电池的温度

电池的温度如表 3 所示，在充电前应使已发热的电池冷却片刻。

表 3

电池	可以对电池进行充电的温度
BSL1415S, BSL1415, BSL1415X, BSL1420, BSL1425, BSL1430, BSL1440, BSL1450, BSL1460	-10°C - 50°C
BSL1815S, BSL1815, BSL1815X, BSL1820, BSL1825, BSL1830, BSL1840, BSL1850, BSL1860	
BSL2530	
BSL3620, BSL3625, BSL3626, BSL3626X, BSL3660	

## 中文

### (4) 关于充电时间

各种电池所需的充电时间如表 4 所示。

表 4 20°C时的大致充电时间（分钟）

电池容量 (Ah)		电池电压			
		14.4 V	18 V	25.2 V	36 V
锂离子电池	1.3 Ah	15 分钟	15 分钟	—	—
	1.5 Ah	15 分钟	15 分钟	—	—
	2.0 Ah	20 分钟	20 分钟	20 分钟	20 分钟
	2.5 Ah	25 分钟	25 分钟	—	25 分钟
	2.6 Ah	—	—	—	25 分钟
	3.0 Ah	30 分钟	30 分钟	30 分钟	—
	4.0 Ah	40 分钟	40 分钟	—	—
	5.0 Ah	50 分钟	50 分钟	—	—
	6.0 Ah	60 分钟	60 分钟	—	60 分钟

注：

充电时间可能会因环境温度而异。

4. 将充电器的电源线从插座上拔下。
5. 拿住充电器，并取出电池。

注：

使用后请务必从充电器取出电池，然后妥善收藏。

### 关于新电池等的放电

因新的和长期未使用的电池内部的化学物质无活性，故第一次和第二次使用时其放电能力可能较低。这是暂时现象，这种电池充电 2 - 3 次后即可恢复其充电所需的正常时间。

### 较长时间保持电池性能的方法

- (1) 在电池电力完全耗尽之前进行充电。

感到电动工具的能力变弱时，请停止使用并给电池充电。若您继续使用电动工具并耗尽电力，电池可能会损坏或其使用寿命缩短。

- (2) 避免在高温环境中充电。

使用后可电池的温度将迅速升高。若使用后立即对这种电池进行充电，其内部化学物质会劣化，电池使用寿命将缩短。请稍等片刻，待电池冷却后再进行充电。



## 注意！

- 如果电池长时间放置在阳光直接照射的地方或者刚刚使用完毕时，电池会发热。如果此时对电池充电，充电器上的充电指示灯会点亮 0.3 秒钟，不点亮 0.3 秒钟（熄灭 0.3 秒钟）。  
在此情况下，先让电池冷却下来，然后再充电。
- 充电指示灯呈快速闪烁（闪烁间隔为 0.2 秒钟）时，请检查充电器的电池连接器内是否有异物并加以清除。若没有异物，则可能是电池或充电器发生了故障，请将其送往当地授权服务中心。
- 因内置的微机需要约 3 秒钟才能确认正用 UC36YSL 进行充电的电池已被取出，因此请等待 3 秒钟后再重新插入电池继续充电。如果在不到 3 秒内就插入电池，则电池可能充电不正常。
- 充电时，请勿用布等挡住通风孔。

## 维护和检查

1. 检查安装的螺丝  
定期检查所有安装的螺丝，确保螺丝已完全拧紧。如果螺丝松动，请立即重新拧紧。否则可能导致严重的危险。
2. 清洁充电器  
当充电器脏污时，请用柔软的干布或沾有肥皂水的布片擦拭。请勿使用会溶化塑料的含氯溶剂、汽油或油漆稀释剂。
3. 收藏停用的充电器  
充电器不用时，应收藏在干燥、较高或上锁（小孩拿不到）的地方。
4. 维修零部件一览表

## 注意！

日立牌电动工具的维修、改造和检查须由经日立公司授权的维修中心进行。当要求维修或其他保养服务时，若将此零部件一览表与电动工具一起呈交给经日立公司授权的维修中心，将有助于维修或保养工作。在操作和维修电动工具时，必须遵守贵国制定的安全的有关规则和标准。

# 维修零部件一览表

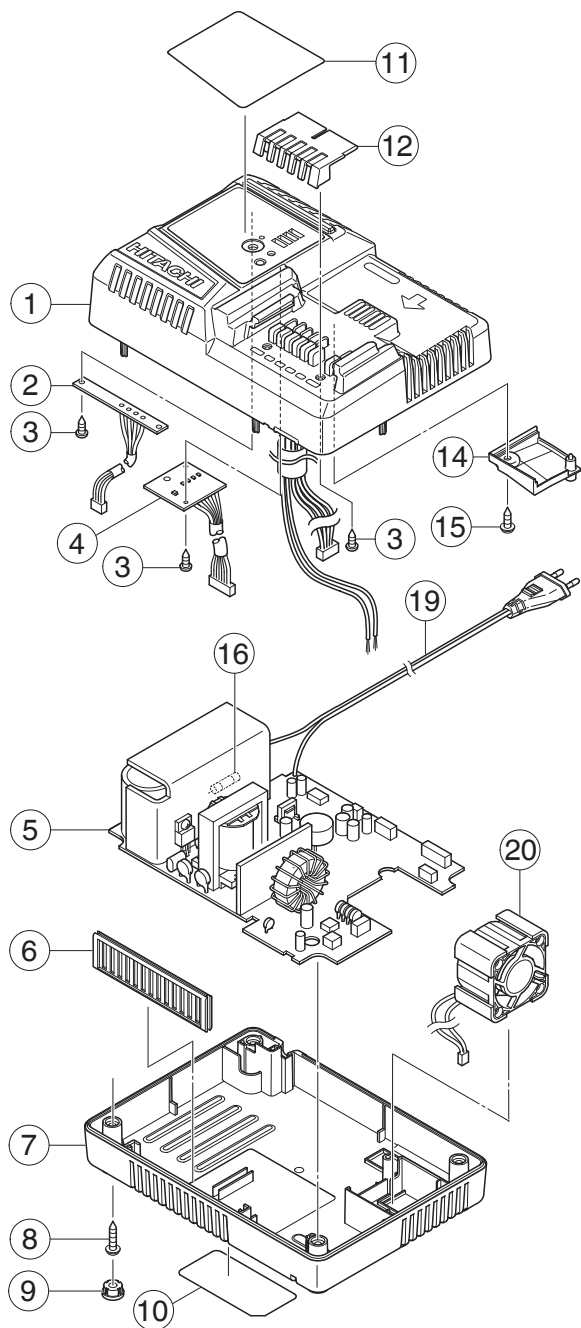

项目号	零件名称	数量
1	外壳 (A)	1
2	LED PCB	1
3	自攻螺丝 (附法兰) D2×8	6
4	开关 PCB	1
5	印刷电路板总成	1
6	过滤器	1
7	外壳 (B)	1
8	自攻螺丝 (附法兰) D3×18	4
9	橡胶 (A)	4
10	铭牌	1
11	日立标签	1
12	盖子	1
14	风道	1
15	TP 自攻螺丝 D3×8	1
16	保险丝 (10A/250V)	1
19	电线	1
20	风扇	1

## CONTENTS

GENERAL OPERATIONAL PRECAUTIONS.....	12
PRECAUTIONS FOR CHARGER.....	13
SYMBOL.....	13
SPECIFICATIONS.....	14
APPLICATIONS.....	14
CHARGING.....	15
MAINTENANCE AND INSPECTION.....	19
SERVICE PARTS LIST.....	20

## GENERAL OPERATIONAL PRECAUTIONS

1. **Keep work area clean. Cluttered areas and benches invite accidents.**
2. **Avoid dangerous environment. Don't expose power tools and charger to rain. Don't use power tools and charger in damp or wet locations. And keep work area well lit. Never use power tools and charger near flammable or explosive materials. Do not use tool and charger in presence of flammable liquids or gases.**
3. **This appliance is not intended for use by persons (including children) with reduced physical, sensory or mental capabilities, or lack of experience and knowledge, unless they have been given supervision or instruction concerning use of the appliance by a person responsible for their safety. Children should be supervised to ensure that they do not play with the appliance.**
4. **Store idle tools and charger. When not in use, tools and charger should be stored in dry, high or lock-up place — out of reach of children. Store tools and charger in a place in which the temperature is less than 40°C.**
5. **Don't abuse cord. Never carry charger by cord or yank it to disconnect from receptacle. Keep cord from heat, oil and sharp edges.**
6. **When the charger is not in use or when being maintained and inspected, disconnect the power cord of the charger from the receptacle.**
7. **To avoid danger, always use only the specified charger.**
8. **Use only genuine HITACHI replacement parts.**
9. **Do not use power tools and charger for applications other than those specified in the Handling Instructions.**
10. **To avoid personal injury, use only the accessories or attachment recommended in these handling instructions or in the HITACHI catalog.**
11. **If the supply cord is damaged, it must be replaced by the manufacture or its service agent or a similarly qualified person in order to avoid a hazard. Let only the authorized service center do the repairing. The Manufacture will not be responsible for any damages or injuries caused by repair by the unauthorized persons or by mishandling of the tool.**
12. **To ensure the designed operational integrity of power tools and charger, do not remove installed covers or screws.**
13. **Always use the charger at the voltage specified on the nameplate.**

14. Always charge the battery before use.
15. Never use a battery other than that specified. Do not connect a usual dry cell, a battery other than that specified or a car battery to the power tool.
16. Do not use a transformer containing a booster.
17. Do not charge the battery from DC power supply.
18. Always charge indoors. Because the charger and battery heat slightly during charging, charge the battery in a place not exposed to direct sunlight; where the humidity is low and the ventilation is good.
19. Use the exploded assembly drawing on this handling instructions only for authorized servicing.

## PRECAUTIONS FOR CHARGER

1. Always charge the battery at an ambient temperature of  $-10$ – $40^{\circ}\text{C}$ . A temperature of less than  $-10^{\circ}\text{C}$  will result in over charging which is dangerous. The battery cannot be charged at a temperature greater than  $40^{\circ}\text{C}$ .  
The most suitable temperature for charging is that of  $20 - 25^{\circ}\text{C}$ .
2. Do not use the charger continuously.  
When one charging is completed, leave the charger for about 15 minutes before the next charging of battery.
3. Do not allow foreign matter to enter the hole for connecting the battery.
4. Never disassemble the battery and charger.
5. Never short-circuit the battery.  
Short-circuiting the battery will cause a great electric current and overheat. It results in burn or damage to the battery.
6. Do not dispose of the battery in fire.  
If the battery is burnt, it may explode.
7. Using an exhausted battery will damage the charger.
8. Bring the battery to the shop from which it was purchased as soon as the post-charging battery life becomes too short for practical use. Do not dispose of the exhausted battery.
9. Do not insert object into the air ventilation slots of the charger.  
Inserting metal objects or inflammables into the charger air ventilation slots will result in electrical shock hazard or damaged charger.

## SYMBOL

### WARNING

The following show symbols used for the machine. Be sure that you understand their meaning before use.



Read all safety warnings and all instructions.

## SPECIFICATIONS

### CHARGER

( ): cells

Charging time	1.3 Ah	BSL1415S (4), BSL1815S (5)	Approx. 15 minutes
	1.5 Ah	BSL1415 (4), BSL1415X (4), BSL1815 (5), BSL1815X (5)	Approx. 15 minutes
	2.0 Ah	BSL1420 (4), BSL1820 (5), BSL3620 (10)	Approx. 20 minutes
	2.5 Ah	BSL1425 (4), BSL1825 (5), BSL3625 (10)	Approx. 25 minutes
	2.6 Ah	BSL3626 (20), BSL3626X (20)	Approx. 25 minutes
	3.0 Ah	BSL1430 (8), BSL1830 (10), BSL2530 (14)	Approx. 30 minutes
	4.0 Ah	BSL1440 (8), BSL1840 (10)	Approx. 40 minutes
	5.0 Ah	BSL1450 (8), BSL1850 (10)	Approx. 50 minutes
	6.0 Ah	BSL1460 (8), BSL1860 (10), BSL3660 (20)	Approx. 60 minutes
Charging voltage	14.4 V – 36 V		
Weight	0.9 kg		

## APPLICATIONS

For charging the HITACHI BATTERY.

- BSL1415S, BSL1415, BSL1415X, BSL1420, BSL1425, BSL1430, BSL1440, BSL1450, BSL1460, BSL1815S, BSL1815, BSL1815X, BSL1820, BSL1825, BSL1830, BSL1840, BSL1850, BSL1860, BSL2530, BSL3620, BSL3625, BSL3626, BSL3626X, BSL3660

## CHARGING

Before using the power tool, charge the battery as follows.

1. Connect the charger's power cord to the receptacle. **(Fig. 1)**

When connecting the plug of the charger to a receptacle, the charge indicator lamp will blink in red. (At 1-second intervals)

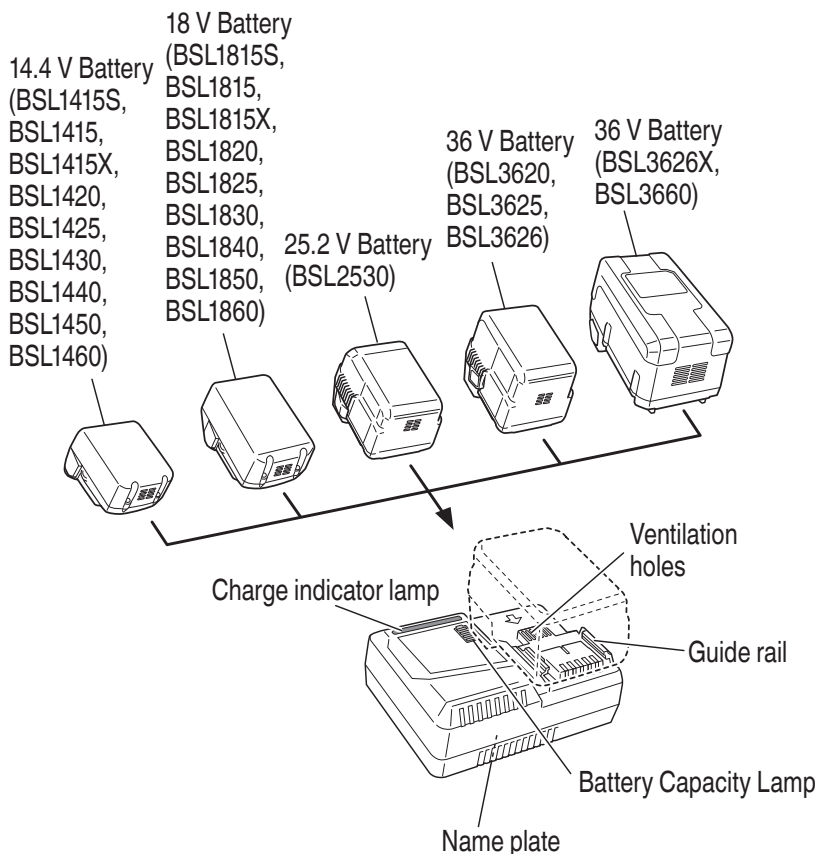





Before insert

**Fig. 1**

# English

2. Insert the battery into the charger.  
Firmly insert the battery into the charger, as shown in **Fig. 1 on page 15**.
  3. Charging  
When inserting a battery in the charger, the charge indicator lamp will light up continuously in blue.  
When the battery becomes fully recharged, the charge indicator lamp will light up continuously in green. (See **Table 1**)
- (1) Charge indicator lamp indication  
The indications of the charge indicator lamp will be as shown in **Table 1**, according to the condition of the charger or the battery.

**Table 1**

Indications of the charge indicator lamp				
Charge indicator lamp (RED / BLUE / GREEN / PURPLE)	Before charging	Blinks (RED)	Lights for 0.5 seconds. Does not light for 0.5 seconds. (off for 0.5 seconds) 	Plugged into power source
	While charging	Lights (BLUE)	Lights continuously 	
	Charging complete	Lights (GREEN)	Lights continuously  (Continuous buzzer sound: about 6 seconds)	Battery overheated. Unable to charge. (Charging will commence when battery cools)
	Overheat standby	Blinks (RED)	Lights for 0.3 seconds. Does not light for 0.3 seconds. (off for 0.3 seconds) 	
	Charging impossible	Flickers (PURPLE)	Lights for 0.1 seconds. Does not light for 0.1 seconds. (off for 0.1 seconds)  (Intermittent buzzer sound: about 2 seconds)	

**NOTE**

When standby for cooling battery, UC36YSL cools the overheated battery by cooling fan.





- (2) About the Battery Capacity Lamp  
The charge capacity of a battery that is charging can be checked using the battery capacity indicator lamp.  
The lamp's indications for the battery capacity are as shown in **Table 2**.

**NOTE**

A short time after charging is complete, the battery capacity lamp turns off.



Table 2

State of lamp	Battery capacity
 Blinks	Battery capacity at less than 25%
 Blinks	Battery capacity at less than 50%
 Blinks	Battery capacity at less than 75%
 Blinks	Battery capacity at more than 75%
 Lights	Charging complete

(3) Regarding the temperature of the battery.

The temperatures for batteries are as shown in the **Table 3**, and batteries that have become hot should be cooled for a while before being recharged.

Table 3

Batteries	Temperature which the battery can be recharged
BSL1415S, BSL1415, BSL1415X, BSL1420, BSL1425, BSL1430, BSL1440, BSL1450, BSL1460	-10°C – 50°C
BSL1815S, BSL1815, BSL1815X, BSL1820, BSL1825, BSL1830, BSL1840, BSL1850, BSL1860	
BSL2530	
BSL3620, BSL3625, BSL3626, BSL3626X, BSL3660	

## English

(4) Regarding recharging time

**Table 4** shows the recharging time required according to the type of battery.

**Table 4 Recharging time (approx.) at 20°C**

Battery capacity (Ah)		Battery Voltage			
		14.4 V	18 V	25.2 V	36 V
Li-ion Battery	1.3 Ah	15 min.	15 min.	—	—
	1.5 Ah	15 min.	15 min.	—	—
	2.0 Ah	20 min.	20 min.	20 min.	20 min.
	2.5 Ah	25 min.	25 min.	—	25 min.
	2.6 Ah	—	—	—	25 min.
	3.0 Ah	30 min.	30 min.	30 min.	—
	4.0 Ah	40 min.	40 min.	—	—
	5.0 Ah	50 min.	50 min.	—	—
	6.0 Ah	60 min.	60 min.	—	60 min.

### NOTE

The recharging time may vary according to the ambient temperature.

4. Disconnect the charger's power cord from the receptacle.

5. Hold the charger firmly and pull out the battery.

### NOTE

Be sure to pull out the battery from the charger after use, and then keep it.

### Regarding electric discharge in case of new batteries, etc.

As the internal chemical substance of new batteries and batteries that have not been used for an extended period is not activated, the electric discharge might be low when using them the first and second time. This is a temporary phenomenon, and normal time required for recharging will be restored by recharging the batteries 2–3 times.

### How to make the batteries perform longer.

(1) Recharge the batteries before they become completely exhausted.

When you feel that the power of the tool becomes weaker, stop using the tool and recharge its battery. If you continue to use the tool and exhaust the electric current, the battery may be damaged and its life will become shorter.

(2) Avoid recharging at high temperatures.

A battery will be hot immediately after use. If such a battery is recharged immediately after use, its internal chemical substance will deteriorate, and the battery life will be shortened. Leave the battery and recharge it after it has cooled for a while.

**CAUTION**

- If the battery is charged while it is heated because it has been left for a long time in a location subject to direct sunlight or because the battery has just been used, the charge indicator lamp of the charger lights for 0.3 seconds, does not light for 0.3 seconds (off for 0.3 seconds). In such a case, first let the battery cool, then start charging.
- When the charge indicator lamp flickers (at 0.2-seconds intervals), check for and take out any foreign objects in the charger's battery connector. If there are no foreign objects, it is probable that the battery or charger is malfunctioning. Take it to your authorized Service Center.
- Since the built-in micro computer takes about 3 seconds to confirm that the battery being charged with UC36YSL is taken out, wait for a minimum of 3 seconds before reinserting it to continue charging. If the battery is reinserted within 3 seconds, the battery may not be properly charged.
- Do not block the ventilation holes with cloth or other materials while charging.

**MAINTENANCE AND INSPECTION**

1. Inspecting the mounting screws  
Regularly inspect all mounting screws and ensure that they are properly tightened. Should any of the screws be loose, retighten them immediately. Failure to do so could result in serious hazard.
2. Cleaning of the charger  
When the charger is stained, wipe with a soft dry cloth or a cloth moistened with soapy water. Do not use chloric solvents, gasoline or paint thinner, for they melt plastics.
3. Store idle charger  
When not in use, the charger should be stored in dry, high or locked-up place — out of reach of children.
4. Service parts list

**CAUTION**

**Repair, modification and inspection of Hitachi Power Tools must be carried out by a Hitachi Authorized Service Center.**

**This Parts List will be helpful if presented with the tool to the Hitachi Authorized Service Center when requesting repair or other maintenance. In the operation and maintenance of power tools, the safety regulations and standards prescribed in each country must be observed.**

# SERVICE PARTS LIST

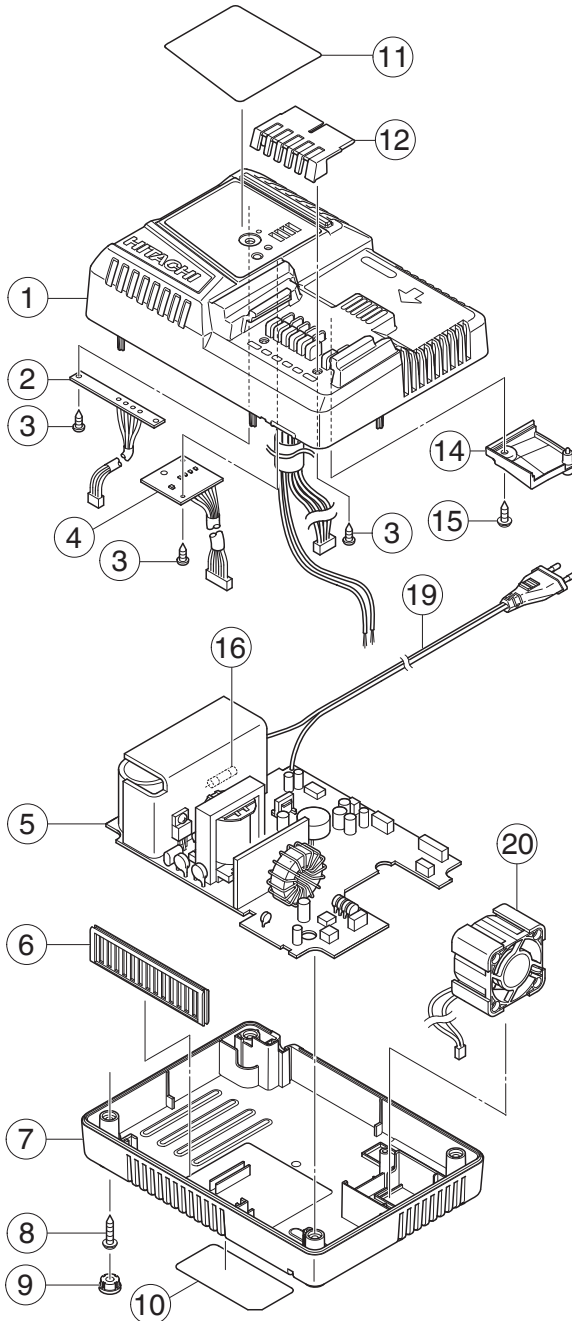

Item No.	Part Name	Q'TY
1	CASE (A)	1
2	LED PCB	1
3	TAPPING SCREW (W/FLANGE) D2X8	6
4	SWITCH PCB	1
5	PRINTED CIRCUIT BOARD ASS'Y	1
6	FILTER	1
7	CASE (B)	1
8	TAPPING SCREW (W/FLANGE) D3X18	4
9	RUBBER (A)	4
10	NAME PLATE	1
11	HITACHI LABEL	1
12	COVER	1
14	AIR DUCT	1
15	TP TAPPING SCREW D3X8	1
16	FUSE (10A/250V)	1
19	CORD	1
20	FAN	1

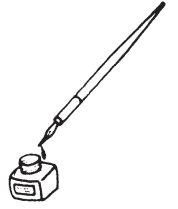

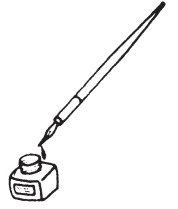

服务中心  
日立工机商业(中国)有限公司  
上海市闵行区浦江工业园区三鲁路3585号7幢3楼

制造商  
广东日立工机有限公司  
广东省广州市番禺区化龙镇工业路富裕围工业村

 **Hitachi Koki Co., Ltd.**

707  
编号：C99716322 G  
发行日期：2017年7月  
中国印刷